





ERV8



Redefining Comfort and Efficiency

ERV8(Combinable series)

HP	8-20	22-28	30-38
Single Unit			

HP	40-76	78-114
Combined Unit		

Note: Four unit combinations are possible for 8-26 HP models. For four unit combinations please contact Eminent.



Original communication bus chip greatly simplifies installation and saves installation costs.



Benefits

- Flexible installation
- Low installation cost
- High reliability
- Stable operation

HyperLink communication technology supports any wiring pattern rather than just daisy chain connection, reducing installation costs and the possibility of an incorrect connection. It has stronger anti-interference ability, achieving a communication distance of up to 2000m.

Arbitrary Topology Communication

In addition to the traditional daisy chain connection, the communication wire supports tree connection, star connection, ring connection and so on. The wiring is flexible, which greatly reduces installation costs and has no possibility of wrong connection on site.

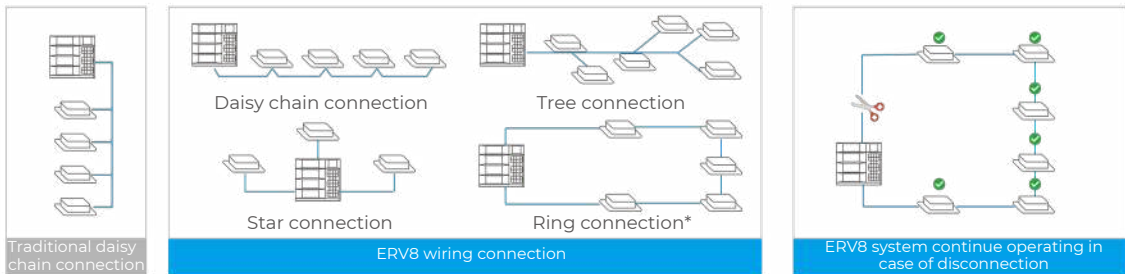

*In ring connection, the communication wire must be connected polarized (M1 port to M1 port and M2 port to M2 port).

Super Anti-interference Capability

Special waveform restoration technology enhances anti-interference performance for more stable communication.



Flexible Power Supply for Indoor Units

HyperLink's unique communication method allows the indoor units to be powered not only by a uniform power supply, but also by individual and zone power supplies, making it particularly suitable for each shop in a large complex building, which can independently power on and off its own indoor units.

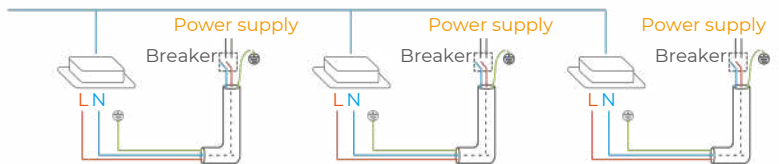

IP55 fully enclosed electric control box provides all-round protection for internal electronic components, greatly improving system **RELIABILITY**.



Anti-corrosion



Dustproof



Rain & Weatherproof



Insect proof

Benefits



High reliability



Stable operation

■ IP (INGRESS PROTECTION)

IP	Dustproof grade code Prevent entry foreign objects and dust
	55 Waterproof grade code Prevent water spray in all directions

Fully enclosed electronic components are isolated from the external environment to protect against corrosion, sand, humidity, snowstorms and other harsh conditions, and prevent small animals and insects from entering the chamber. This protects internal electronic devices and improves the overall environmental tolerance.

All Microchannel Refrigerant Cooling

All electronic components including inverter module, filter module and power module are cooled by specially designed microchannel refrigerant to ensure that the electronic components work in the best temperature range.



PTC Heater

The unique PTC heater, with precise temperature control sensor, can still ensure that the temperature inside the chamber remains within the normal operating temperature range of electronic devices even in the low-temperature environment of -30°C.

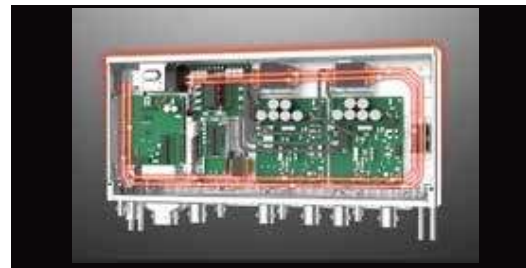

Built-in Circulating Fan

The built-in circulating fan accelerates the air flow inside the chamber, and the heat exchange is more sufficient to ensure the consistent ambient temperature inside the chamber.



5 High Precision Temperature Sensors

5 high precision temperature sensors are used to accurately monitor the operation state of electronic control under various conditions to ensure that the internal temperature of the chamber is always kept within a stable range.

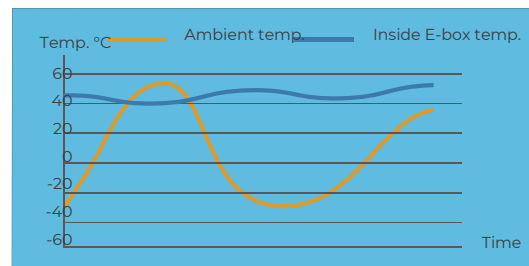

The status of the refrigerant can be determined throughout the process, ensuring high **RELIABILITY** and **COMFORT**.



Benefits

-  High reliability
-  Stable operation
-  Enhanced comfort

Up to 19 sensors are distributed throughout the refrigerant system, and the status of the refrigerant can be determined throughout the process, ensuring stable operation. At the same time, combined with the digital twin technology of the refrigerant system, a virtual sensor can be created in the event of a physical sensor failure, so that the system does not shut down in the event of a sensor failure, ensuring comfort.

Complete Sensors

The ERV8 Series VRF features the industry's most comprehensive range of 19 condition sensors with built-in data models for compressors, heat exchangers, throttling components and more. By analyzing sensor data in real time, it can sense the status of the refrigerant anywhere in the system.

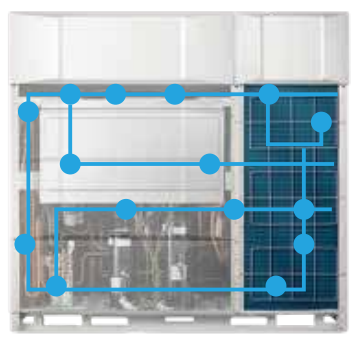

Refrigerant Amount Diagnosis

Thanks to the complete sensors, the refrigerant running state is clearly visible, so as to accurately diagnose the amount of refrigerant.

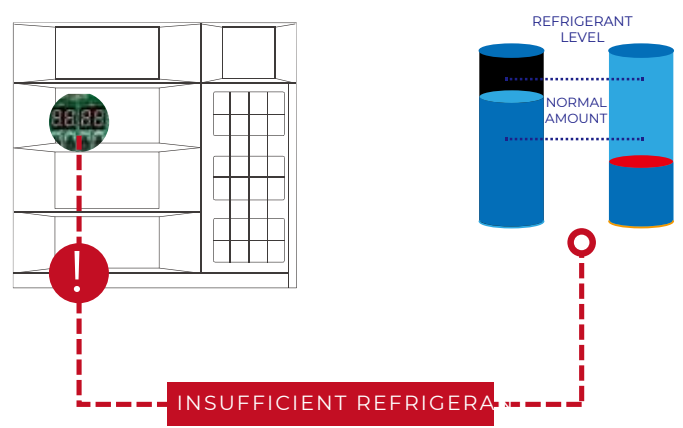

Virtual Sensor Backup

In the event of a sensor failure, other sensors can automatically simulate a virtual backup sensor, so that the VRF system can continue to operate without stopping.

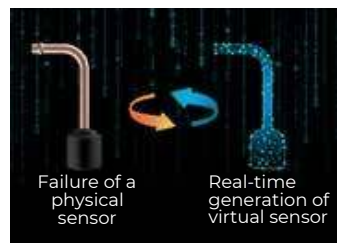

ERV8 ETA

ETA is the abbreviation of Evaporating Temperature Alteration. Further upgraded ETA technology to maximize **ENERGY SAVING**.



Benefits

- Energy saving
- Enhanced comfort
- Fast cooling/heating

Built-in professional operation and maintenance algorithm, so that the annual operation energy efficiency of each set of systems is increased by more than 28%.

Variable Refrigerant Flow

STEP 1: Architectural space feature recognition

The indoor unit automatically recognizes the size of the building space and the effectiveness of the insulation according to the rate of temperature drop.

Automatic calculation of the building load and the required refrigerant quantity based on the sensor parameters.

Variable Refrigerant Temperature

STEP 2: System refrigerant temperature determination

The system automatically matches the evaporating temperature (in cooling) or condensing temperature (in heating) to the room load to maximize comfort and energy efficiency.

Automatic matching of the corresponding refrigerant temperature to the load.

Variable Indoor Airflow

STEP 3: Adaptive indoor airflow and refrigerant flow

Each indoor unit automatically adjusts the corresponding indoor airflow and refrigerant flow according to the evaporating/condensing temperature, enabling precise temperature control.

Automatic matching of the corresponding indoor airflow to the load and refrigerant temperature.

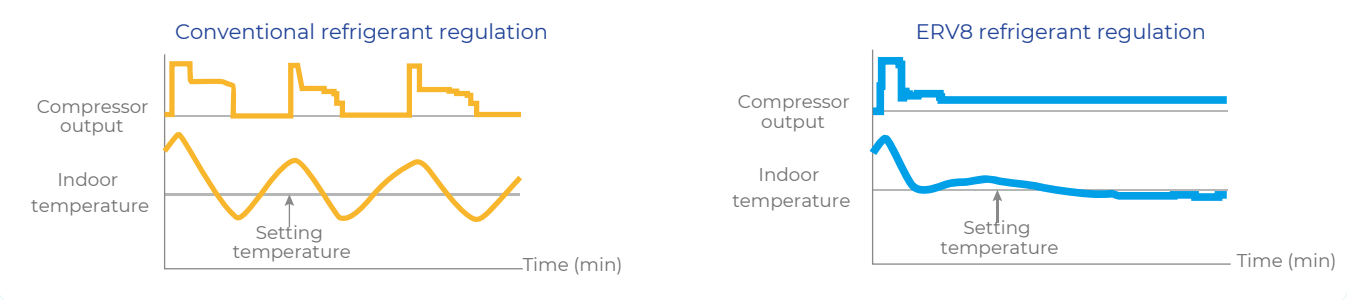

High Efficiency

Full DC Inverter Technology

Full DC Inverter for Outdoor Components

The ERV8 Series VRF uses full DC inverter compressor and fan motor to achieve high precision stepless speed adjustment according to system operation, and ensures that the system is always in optimum condition, operating more efficiently, more consistently and with less noise.

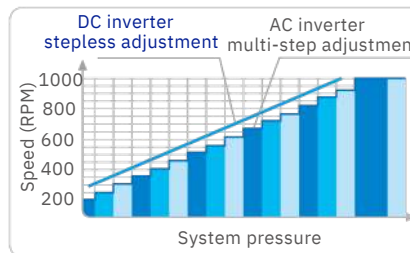
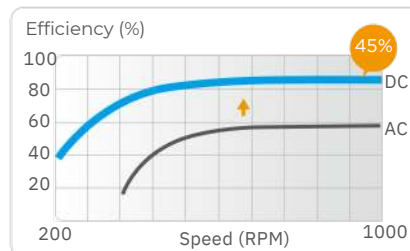

Wider frequency adjustment range

Faster cooling and heating

Higher energy efficiency

All power devices such as indoor fan motor, drain pump and electric control board are fully DC, which increases electrical efficiency by 20% and results in more accurate temperature control, a more constant indoor temperature and higher energy efficiency.

Full DC Inverter for Indoor Components

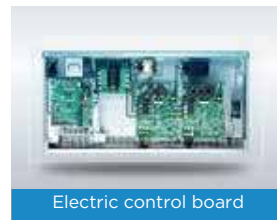

20%
Efficiency improvements

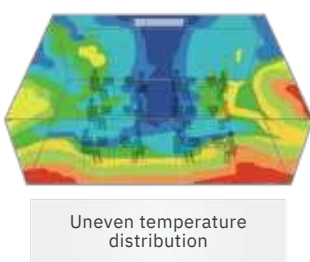

VS

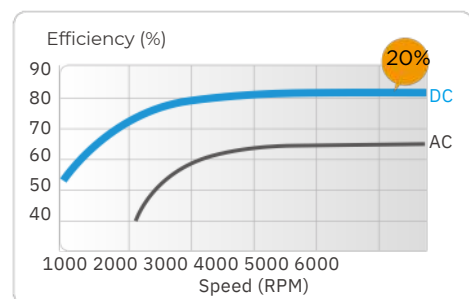
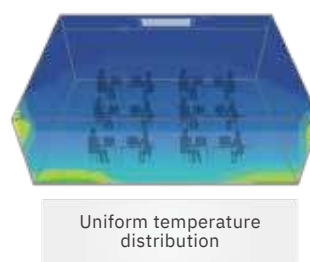

Enhanced Vapor Injection (EVI) Compressor

The enhanced vapor injection DC inverter compressor increases refrigerant circulation and improves both cooling and heating capacity.

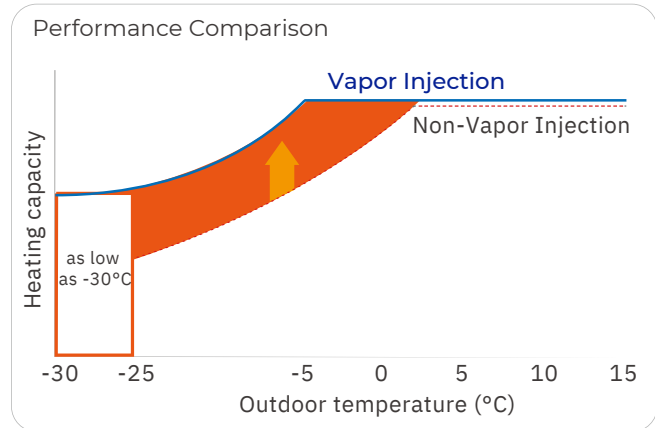
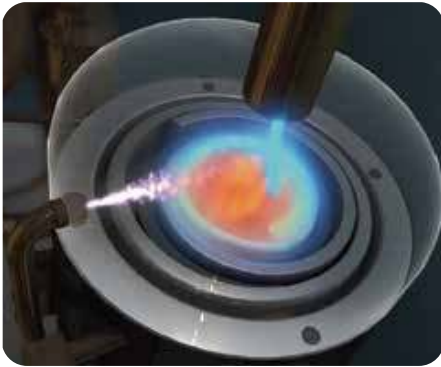

Advanced Subcooling Technology

The ERV8 Series VRF uses a micro-channel heat exchanger to further cool the refrigerant and the refrigerant system can achieve 15°C refrigerant subcooling, which can further improve the refrigerant heat transfer efficiency while reducing the sound of refrigerant flow.

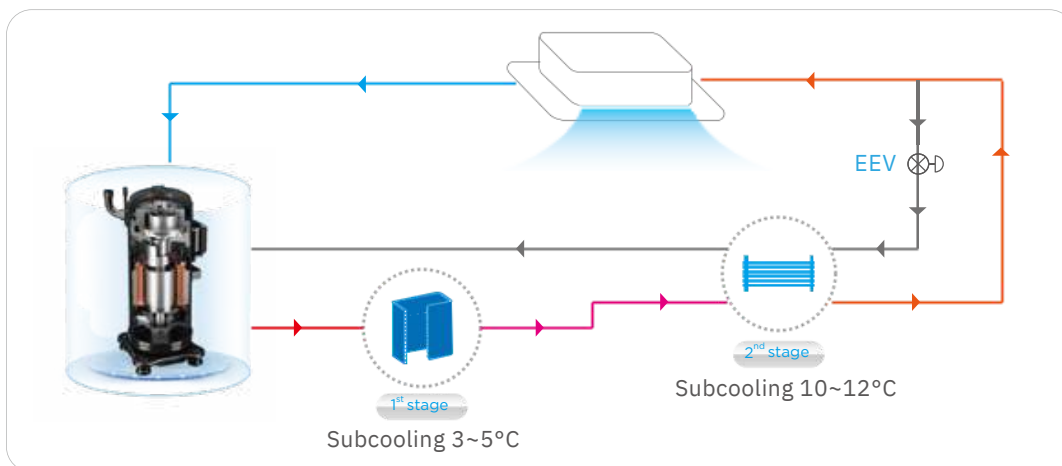

Low Standby Power Consumption

Compared to the standby power consumption of traditional VRF of about 30W, the ERV8 Series VRF uses optimized control scheme to further reduce standby power consumption to as low as 3.5W.

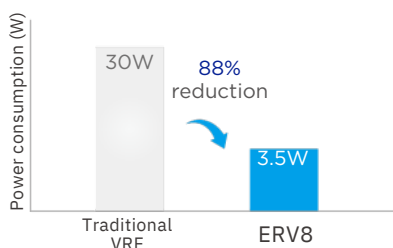

60-step Energy Management

For projects with temporary electricity supply restrictions, the outdoor unit supports 60-step energy management which can be set to output 40-100% capacity in 1% increments. It prevents tripping during conditions of restricted electricity supply and allows the system to continue to operate.

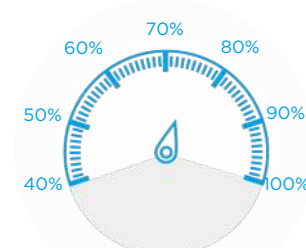

High Reliability



▣ Quadruple Backup

In two fans, two compressors and multiple units, one can run in backup for another. Additionally, the ERV8 series VRF generates a corresponding virtual sensor for each physical sensor by means of a digital algorithm, which serves as a backup for each other, ensuring no shutdown in the event of a fault, and further guaranteeing comfort.

1 Unit Backup

In a multi-unit system, the different units act as a backup to each other, ensuring that the system can continue to operate if one unit fails.



Intelligent load-bearing between units during normal operation

2 Fan Backup

In unit with two fans, the two fans act as a backup to each other, ensuring that the system can continue to operate if one fan fails.



In normal operation, each fan runs on demand



Continue operating in case of failure of one unit

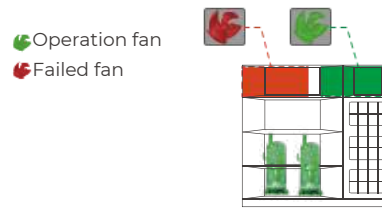

Automatic backup operation of another fan in case of failure of one fan

3 Compressor Backup

In unit with two compressors, the two compressors act as a backup to each other, ensuring that the system can continue to operate if one compressor fails.



Intelligent load-bearing between compressors during normal operation



Continue operating in case of failure of one compressor

4 Sensor Backup



Through digital algorithms, each physical sensor generates a corresponding virtual sensor that acts as a backup to each other, ensuring that the failure of one sensor does not affect the normal operation of the system.



Automatic backup operation of the corresponding virtual sensor in case of failure of one physical sensor

Double Duty Cycling

1 Unit Duty Cycling

In a multi-unit system, duty cycling equalizes the running time of each outdoor unit, significantly extending unit lifespan.

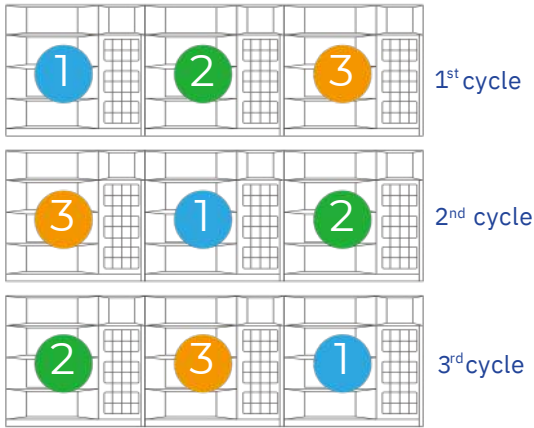

Note: The duty cycling sequence shown in the figure is only a schematic reference. The actual duty cycling sequence is not a fixed sequence. Please refer to the technical manual for specific rotation rules.

2 Compressor Duty Cycling

In units with two compressors, duty cycling equalizes the running time of each compressor, significantly extending compressor lifespan.

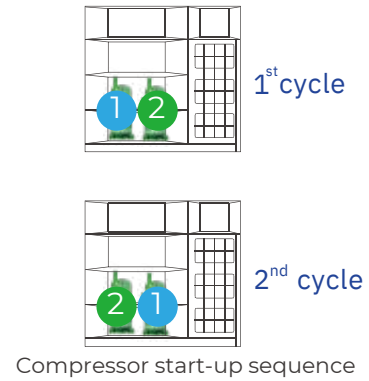

ShieldBox

IP55 fully enclosed electric control box provides all-round protection for internal electronic components, greatly improving system reliability.



SuperSense

ERV8 Series VRF uses up to 19 sensors for each outdoor unit and 4 sensors for each indoor unit. The operating status of the system refrigerant is clearly visible, which can achieve intelligent analysis of operation parameters, intelligent error diagnosis and forecasting, and visualized energy saving.



Precise Oil Control

Four stages of oil control technology ensure all outdoor compressor oil is always kept at a safe level, eliminating any compressor oil shortage problems.

1

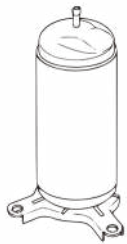

Compressor internal oil separation.

2



High-efficiency centrifugal oil separator (with separation efficiency of up to 99%) ensures that oil is separated from the discharge gas and returned to the compressors in a timely fashion.

3

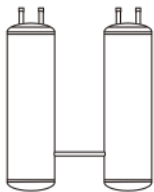

Oil balance pipes between gas-liquid separator ensure even oil distribution to keep compressors running normally.

4

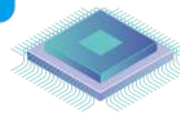

The automatic oil return program determines the oil return through the running time and the oil discharge amount, enabling precise oil return.

Heavy Anti-corrosion Protection*

Standard outdoor units are given anti-corrosion treatment for non-extreme conditions and can also be customized with heavy anti-corrosion treatment on main components for surface protection against corrosive air, acid rain and saline air (for installations in coastal regions) to extend overall useful life. The integrity of the anti-corrosion treatment is ensured by subjecting major components and parts to salt mist testing, moisture and heating testing and light aging testing.

*Heavy anti-corrosion treatment is available as a customization option.



Auto Snow-blowing Function

The innovatively designed auto snow-blowing function enables the outdoor unit to prevent the accumulation of snow by itself.



Auto Dust-clean Function

The innovatively designed dust-clean function enables the outdoor unit to prevent the dust by itself.



Auto Dust-clean Function

The innovatively designed dust-clean function enables the outdoor unit to prevent the dust by itself.



Enhanced Comfort

Advanced Silent Technology

15-step silent mode provides more freedom and convenience to match the customer needs.

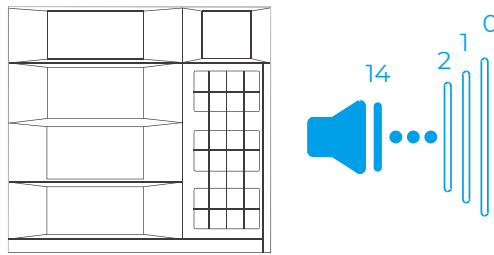

15 silent options

Auto Cooling-heating Changeover

Automatically selects cooling or heating mode to achieve the set temperature.

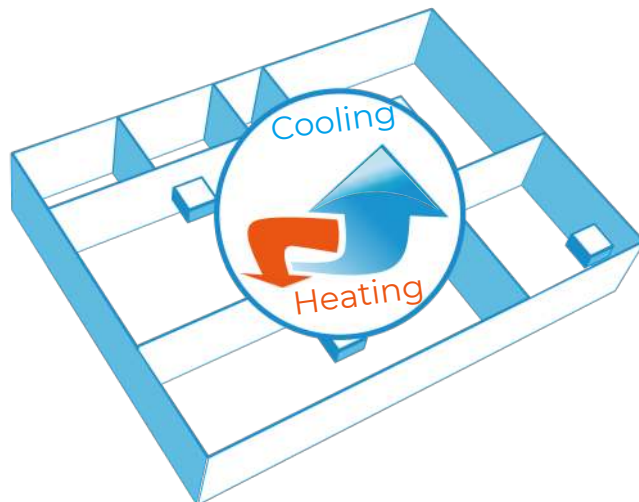

Enhanced Comfort

10 Priority Modes

10 priority mode options provide more freedom and convenience to match the customer needs.

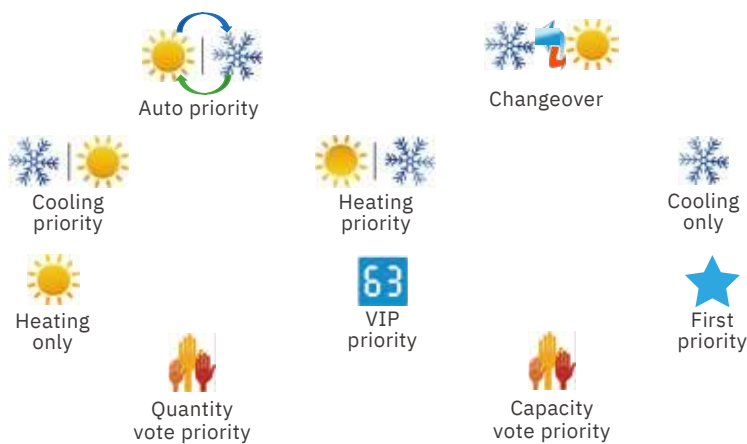

Additional Ambient Temperature Sensor*

The ERV8 Series VRF can be equipped with an additional external ambient temperature sensor to determine whether the system is operating in cooling or heating in auto priority mode. For some installations, the ambient temperature sensor fixed on the unit cannot detect the true ambient temperature, resulting in the system operating in an inappropriate mode and affecting indoor comfort. The external ambient temperature sensor can detect the true outdoor ambient temperature, and correctly judge whether the system is running in cooling or heating mode, ensuring indoor comfort.

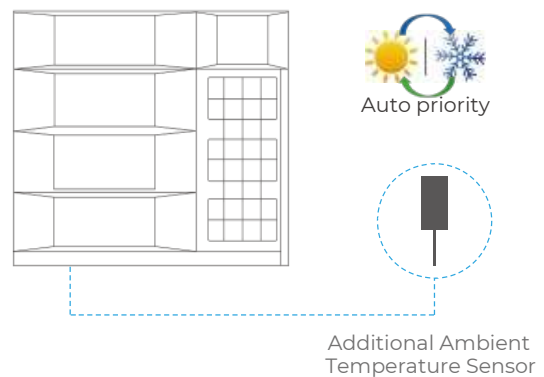

*This function is available as a customization option.

Wide Application Range

Wide Capacity Range

The ERV8 Series can be used as a single module or can be combined up to 3 modules, perfectly suited for small to large buildings.

ERV8 - Combinable Series

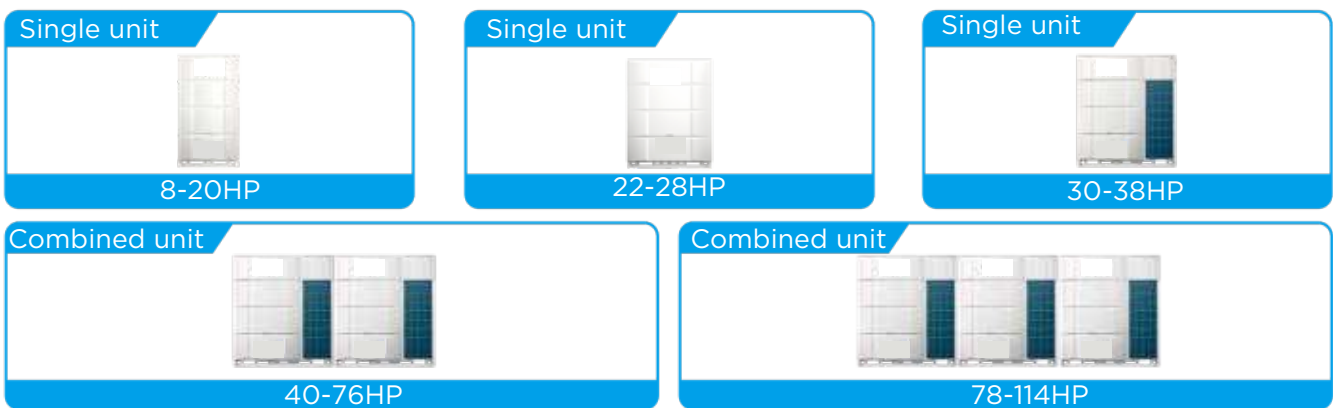

Note: Four unit combinations are possible for 8-26 HP models. For four unit combinations please contact Eminent.

Wide Range of Indoor Units

The ERV8 Series VRF offers types of over 100 models of indoor units to meet different scenarios of applications such as offices, shopping malls, hotels, airports, schools, hospitals, etc.



Wide Operation Range

Thanks to the EVI compressor and refrigerant cooling technology, the ERV8 Series VRF can operate at temperatures as low as -30°C for heating and up to 55°C for cooling.



Long Piping Capability

The ERV8 system can support a total piping length of up to 1100m, an installation height difference of up to 110m between indoor and outdoor units, and up to 40m between indoor units, making the ERV8 Series VRF adaptable to a wide range of building designs.

Total piping length: 1100m

1 Longest piping length - actual (equivalent): 220(260)m

2 Longest piping length after first branch: 40/120*m

3 Level difference between IDUs and ODU - ODU above (below): 110(110)m

4 Level difference between IDUs: 40m

*The longest length after first branch is 40m as a standard but can be extended to up to 120m under certain conditions. Please contact your local dealer for further information.

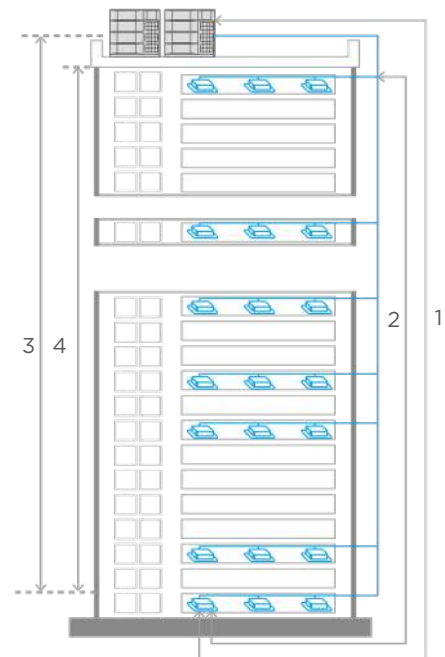

Easy Installation and Service

Free Wiring

HyperLink communication technology supports any wiring pattern rather than just daisy chain connection, reducing the installation cost and the possibility of incorrect connection. It has stronger anti-interference ability, achieving a communication distance of up to 2000m.



Space Saving

The ERV8 Series VRF has large capacity and small size, with a capacity of up to 38 HP in a single unit. A single unit can provide cooling/heating for a space of 400m². The space-saving advantages are particularly obvious for large projects.

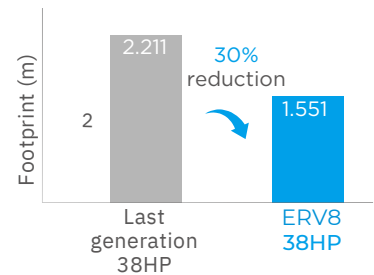
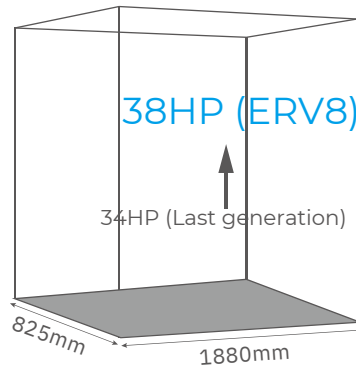

Auto Addressing

Addresses for all indoor units and combined outdoor units can be assigned automatically by the ERV8 system, further simplifying installation.



External Static Pressure up to 120Pa*

The static pressure of the outdoor unit can be up to 120Pa which facilitates installation of the unit on each floor of high-rise buildings or on balconies.

*External static pressure above 20Pa is available as a customization option.

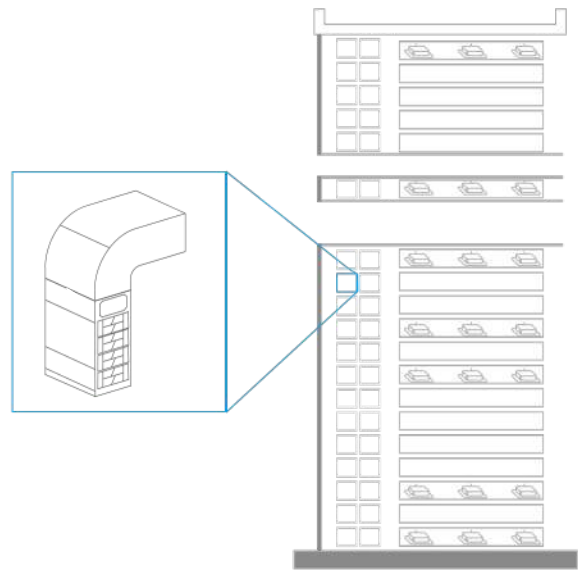

Automatic Refrigerant Charging*

Compared to manual refrigerant charging, automatic refrigerant charging greatly simplifies the process, making installation and maintenance easier and more efficient.

Manual refrigerant charging

- 1 •Calculate additional refrigerant quantity
- 2 •Connect refrigerant tank to the outdoor unit & start the filling process
- 3 •Observe the weight scale to check the refrigerant charge
- 4 •Close the shut-off valve manually & finish the filling process

Automatic refrigerant charging

- 1 •Connect refrigerant tank to the outdoor unit & activate automatic charging function
- 2 •Close the shut-off valve automatically & finish the filling process

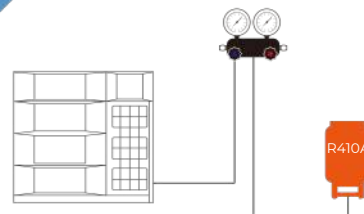

*This function is available as a customization option.

Automatic Refrigerant Recycling

When an indoor unit fails, the refrigerant can be recycled into the outdoor units. When part of the outdoor unit fails, the refrigerant can be recycled into the indoor units and the normal outdoor unit. Two types of refrigerant recycling make the maintenance process easier and more efficient.

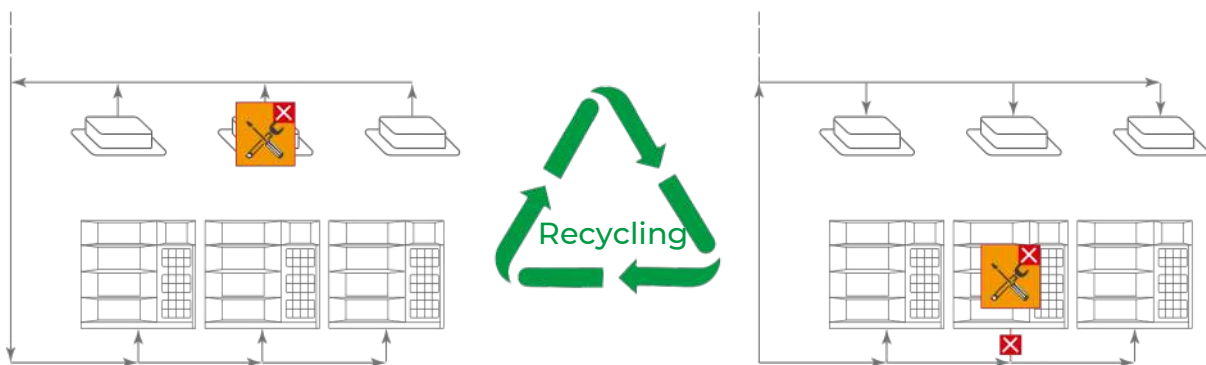

Maintenance Mode

The maintenance mode allows the shutdown of some indoor units without shutting down the whole VRF system, and it can be activated on site during the maintenance period as the remaining indoor units continue to operate.

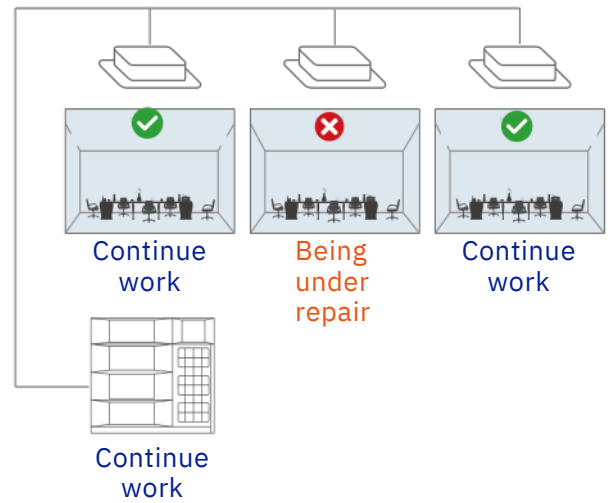

Wide Combination Ratio*

Compared to traditional VRF with combination ratio of 50-130%, the ERV8 Series VRF can be extended to 50-200%, and the wider combination ratio allows for more flexible system configuration. The larger combination ratio can be applied to long-term part-load operation scenarios, allowing for further reduction in installation costs.

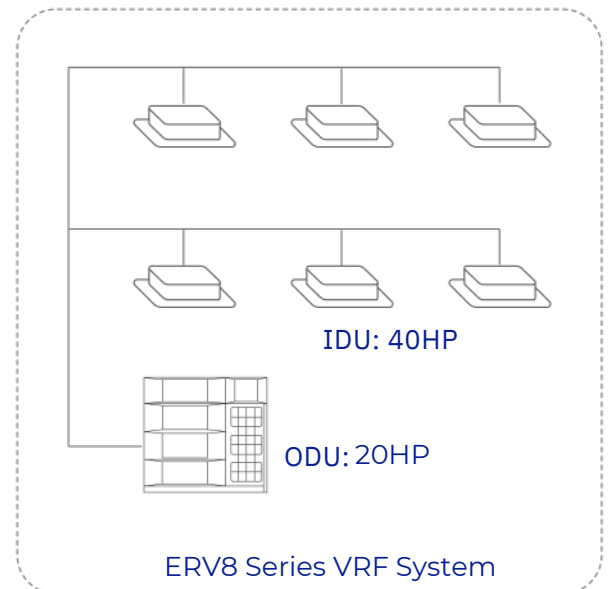
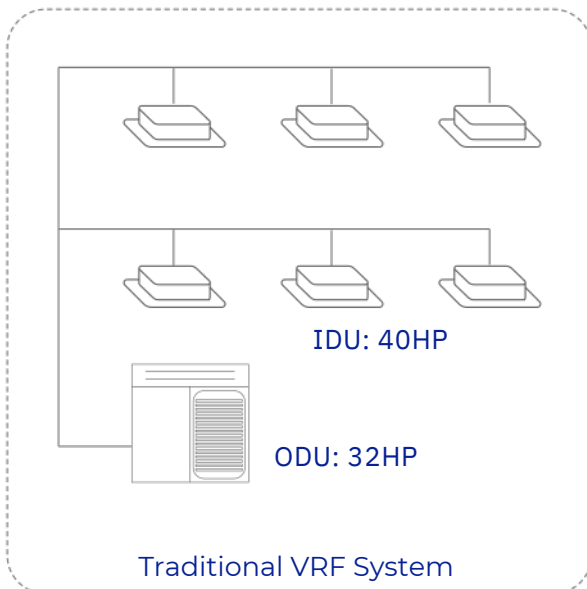

*Combination ratio over 130% is available as a customization option.

Specifications

HP			8	10	12	14
Model			ERV8-086	ERV8-096	ERV8-114	ERV8-137
Power supply		V/ph/Hz	380-415/3/50(60)	380-415/3/50(60)	380-415/3/50(60)	380-415/3/50(60)
Cooling	Capacity	kW	25.2	28	33.5	40
		kBtu/h	86.0	95.5	114.3	136.5
	Power input	kW	5.3	6.5	7.8	9.8
	COP			4.75	4.31	4.29
Heating	Capacity	kW	27	31.5	37.5	45
		kBtu/h	92.1	107.5	128.0	153.5
	Power input	kW	5.0	6.2	7.8	9.5
	COP			5.40	5.08	4.81
Connected indoor unit	Combination ratio		50-130%			
	Maximum quantity		13	16	19	23
Compressors	Type		DC inverter	DC inverter	DC inverter	DC inverter
	Quantity		1	1	1	1
Fan motors	Type		DC	DC	DC	DC
	Quantity		1	1	1	1
	Airflow rate	m ³ /h	12600	12600	13500	14400
	Static pressure	Pa	0-20 (standard) 20-120 (customized)	0-20 (standard) 20-120 (customized)	0-20 (standard) 20-120 (customized)	0-20 (standard) 20-120 (customized)
Refrigerant	Type		R410A	R410A	R410A	R410A
	Factory charge	kg	7	7	7	7
Pipe connections	Liquid pipe	mm	Ø12.7	Ø12.7	Ø12.7	Ø12.7
	Gas pipe	mm	Ø25.4	Ø25.4	Ø25.4	Ø25.4
Sound pressure level		dB(A)	56	57	59	59
Sound power level		dB(A)	83	84	85	86
Net dimensions (W×H×D)		mm	940×1760×825	940×1760×825	940×1760×825	940×1760×825
Packed dimensions (W×H×D)		mm	1005×1945×890	1005×1945×890	1005×1945×890	1005×1945×890
Net weight		kg	195	195	197	197
Gross weight		kg	213	213	215	215
Ambient temp. operation range	Cooling	°C(DB)	-15 to 55	-15 to 55	-15 to 55	-15 to 55
	Heating	°C(DB)	-30 to 30	-30 to 30	-30 to 30	-30 to 30

HP			16	18	20	22
Model			ERV8-154	ERV8-171	ERV8-191	ERV8-210
Power supply		V/ph/Hz	380-415/3/50(60)	380-415/3/50(60)	380-415/3/50(60)	380-415/3/50(60)
Cooling	Capacity	kW	45	50	56	61.5
		kBtu/h	153.5	170.6	191.1	209.8
	Power input	kW	10.7	12.2	14.0	15.6
	COP			4.21	4.10	4.00
Heating	Capacity	kW	50	56	63	69
		kBtu/h	170.6	191.1	215.0	235.4
	Power input	kW	10.7	12.8	14.4	16.6
	COP			4.67	4.38	4.38
Connected indoor unit	Combination ratio		50-130%			
	Maximum quantity		26	29	33	36
Compressors	Type		DC inverter	DC inverter	DC inverter	DC inverter
	Quantity		1	1	1	2
Fan motors	Type		DC	DC	DC	DC
	Quantity		1	1	1	2
	Airflow rate	m ³ /h	15600	15600	16500	22000
	Static pressure	Pa	0-20 (standard) 20-120 (customized)	0-20 (standard) 20-120 (customized)	0-20 (standard) 20-120 (customized)	0-20 (standard) 20-120 (customized)
Refrigerant	Type		R410A	R410A	R410A	R410A
	Factory charge	kg	8	8	8.4	9.3
Pipe connections	Liquid pipe	mm	Ø15.9	Ø15.9	Ø15.9	Ø15.9
	Gas pipe	mm	Ø28.6	Ø28.6	Ø28.6	Ø28.6
Sound pressure level		dB(A)	59	60	61	62
Sound power level		dB(A)	86	88	89	89
Net dimensions (W×H×D)		mm	940×1760×825	940×1760×825	940×1760×825	1340×1760×825
Packed dimensions (W×H×D)		mm	1005×1945×890	1005×1945×890	1005×1945×890	1405×1945×890
Net weight		kg	213	213	215	295
Gross weight		kg	230	230	232	315
Ambient temp. operation range	Cooling	°C(DB)	-15 to 55	-15 to 55	-15 to 55	-15 to 55
	Heating	°C(DB)	-30 to 30	-30 to 30	-30 to 30	-30 to 30

Notes:

- Indoor temperature 27°C DB, 19°C WB; outdoor temperature 35°C DB; equivalent refrigerant piping length 7.5m with zero level difference.
- Indoor temperature 20°C DB; outdoor temperature 7°C DB, 6°C WB; equivalent refrigerant piping length 7.5m with zero level difference.
- Diameters given are those of the unit's stop valves.
- Sound pressure level is measured at a position 1m in front of the unit and 1.3m above the floor in a semi-anechoic chamber.

Specifications

HP			24	26	28	30
Model			ERV8-229	ERV8-250	ERV8-268	ERV8-290
Power supply		V/ph/Hz	380-415/3/50(60)	380-415/3/50(60)	380-415/3/50(60)	380-415/3/50(60)
Cooling	Capacity	kW	67	73	78.5	85
		kBtu/h	228.6	249.1	267.9	290.0
	Power input	kW	17.9	18.8	20.6	22.4
	COP			3.74	3.88	3.81
Heating	Capacity	kW	75	81.5	87.5	95
		kBtu/h	255.9	278.1	298.6	324.2
	Power input	kW	18.5	19.8	21.4	24.4
	COP			4.05	4.12	4.09
Connected indoor unit	Combination ratio		50-130%			
	Maximum quantity		39	43	46	50
Compressors	Type		DC inverter	DC inverter	DC inverter	DC inverter
	Quantity		2	2	2	2
Fan motors	Type		DC	DC	DC	DC
	Quantity		2	2	2	2
	Airflow rate	m ³ /h	22000	21500	21500	29000
	Static pressure	Pa	0-20 (standard) 20-120 (customized)	0-20 (standard) 20-120 (customized)	0-20 (standard) 20-120 (customized)	0-20 (standard) 20-120 (customized)
Refrigerant	Type		R410A	R410A	R410A	R410A
	Factory charge	kg	9.3	12	12	19
Pipe connections	Liquid pipe	mm	Ø15.9	Ø15.9	Ø15.9	Ø22.2
	Gas pipe	mm	Ø28.6	Ø28.6	Ø28.6	Ø31.8
Sound pressure level		dB(A)	62	62	62	63
Sound power level		dB(A)	92	93	93	93
Net dimensions (W×H×D)		mm	1340×1760×825	1340×1760×825	1340×1760×825	1880×1760×825
Packed dimensions (W×H×D)		mm	1405×1945×890	1405×1945×890	1405×1945×890	1945×1945×890
Net weight		kg	295	315	315	373
Gross weight		kg	315	335	335	403
Ambient temp. operation range	Cooling	°C(DB)	-15 to 55	-15 to 55	-15 to 55	-15 to 55
	Heating	°C(DB)	-30 to 30	-30 to 30	-30 to 30	-30 to 30

HP			32	34	36	38
Model			ERV8-307	ERV8-324	ERV8-345	ERV8-362
Power supply		V/N/Hz	380-415/3/50(60)	380-415/3/50(60)	380-415/3/50(60)	380-415/3/50(60)
Cooling	Capacity	kW	90	95.2	101	106
		kBtu/h	307.1	324.8	344.6	361.7
	Power input	kW	24.7	26.4	28.7	30.6
	EER			3.64	3.61	3.52
Heating	Capacity	kW	100	106	112	119
		kBtu/h	341.2	361.7	382.2	406.0
	Power input	kW	26.2	28.3	30.7	33.1
	COP			3.82	3.75	3.65
Connected indoor unit	Combination ratio		50-130%			
	Maximum quantity		53	56	59	62
Compressors	Type		DC inverter	DC inverter	DC inverter	DC inverter
	Quantity		2	2	2	2
Fan motors	Type		DC	DC	DC	DC
	Quantity		2	2	2	2
	Airflow rate	m ³ /h	28000	28000	29000	29000
	Static pressure	Pa	0-20 (standard) 20-120 (customized)	0-20 (standard) 20-120 (customized)	0-20 (standard) 20-120 (customized)	0-20 (standard) 20-120 (customized)
Refrigerant	Type		R410A	R410A	R410A	R410A
	Factory charge	kg	21	21	21	21
Pipe connections	Liquid pipe	mm	Ø22.2	Ø22.2	Ø22.2	Ø22.2
	Gas pipe	mm	Ø34.9	Ø34.9	Ø34.9	Ø34.9
Sound pressure level		dB(A)	64	64	66	66
Sound power level		dB(A)	93	94	94	94
Net dimensions (W×H×D)		mm	1880×1760×825	1880×1760×825	1880×1760×825	1880×1760×825
Packed dimensions (W×H×D)		mm	1945×1945×890	1945×1945×890	1945×1945×890	1945×1945×890
Net weight		kg	405	405	408	408
Gross weight		kg	435	435	438	438
Ambient temp. operation range	Cooling	°C(DB)	-15 to 55	-15 to 55	-15 to 55	-15 to 55
	Heating	°C(DB)	-30 to 30	-30 to 30	-30 to 30	-30 to 30

Notes:

- Indoor temperature 27°C DB, 19°C WB; outdoor temperature 35°C DB; equivalent refrigerant piping length 7.5m with zero level difference.
- Indoor temperature 20°C DB; outdoor temperature 7°C DB, 6°C WB; equivalent refrigerant piping length 7.5m with zero level difference.
- Diameters given are those of the unit's stop valves.
- Sound pressure level is measured at a position 1m in front of the unit and 1.3m above the floor in a semi-anechoic chamber.

Specifications

HP			40	42	44	46
Model (Combination unit)			ERV8-381	ERV8-400	ERV8-421	ERV8-439
Combination type			18HP+22HP	18HP+24HP	18HP+26HP	18HP+28HP
Power supply		V/ph/Hz	380-415/3/50(60)	380-415/3/50(60)	380-415/3/50(60)	380-415/3/50(60)
Cooling	Capacity	kW	111.5	117.0	123.0	128.5
		kBtu/h	380.4	399.2	419.7	438.5
	Power input	kW	27.8	30.1	31.0	32.8
	COP			4.01	3.89	3.97
Heating	Capacity	kW	125.0	131.0	137.5	143.5
		kBtu/h	426.5	447.0	469.2	489.7
	Power input	kW	29.4	31.3	32.6	34.2
	COP			4.25	4.19	4.22
Connected indoor unit	Combination ratio		50-130%			
	Maximum quantity		64			
Compressors	Type		DC inverter	DC inverter	DC inverter	DC inverter
	Quantity		3	3	3	3
Fan motors	Type		DC	DC	DC	DC
	Quantity		3	3	3	3
	Airflow rate	m ³ /h	37600	37600	37100	37100
	Static pressure	Pa	0-20 (standard) 20-120 (customized)	0-20 (standard) 20-120 (customized)	0-20 (standard) 20-120 (customized)	0-20 (standard) 20-120 (customized)
Refrigerant	Type		R410A	R410A	R410A	R410A
	Factory charge	kg	8+9.3	8+9.3	8+12	8+12
Pipe connections	Liquid pipe	mm	Ø19.1	Ø19.1	Ø19.1	Ø19.1
	Gas pipe	mm	Ø38.1	Ø38.1	Ø38.1	Ø38.1
Sound pressure level		dB(A)	64	64	64	64
Sound power level		dB(A)	92	94	94	94
Net dimensions (W×H×D)		mm	(940×1760×825)+ (1340×1760×825)	(940×1760×825)+ (1340×1760×825)	(940×1760×825)+ (1340×1760×825)	(940×1760×825)+ (1340×1760×825)
Packed dimensions (W×H×D)		mm	(1005×1945×890)+ (1405×1945×890)	(1005×1945×890)+ (1405×1945×890)	(1005×1945×890)+ (1405×1945×890)	(1005×1945×890)+ (1405×1945×890)
Net weight		kg	213+295	213+295	213+315	213+315
Gross weight		kg	230+315	230+315	230+335	230+335
Ambient temp. operation range	Cooling	°C(DB)	-15 to 55	-15 to 55	-15 to 55	-15 to 55
	Heating	°C(DB)	-30 to 30	-30 to 30	-30 to 30	-30 to 30

HP			48	50	52	54
Model (Combination unit)			ERV8-461	ERV8-479	ERV8-497	ERV8-516
Combination type			18HP+30HP	24HP+26HP	24HP+28HP	16HP+38HP
Power supply		V/ph/Hz	380-415/3/50(60)	380-415/3/50(60)	380-415/3/50(60)	380-415/3/50(60)
Cooling	Capacity	kW	135.0	140.0	145.5	151.0
		kBtu/h	460.6	477.7	496.5	515.2
	Power input	kW	34.6	36.7	38.5	41.3
	COP			3.90	3.81	3.78
Heating	Capacity	kW	151.0	156.5	162.5	169.0
		kBtu/h	515.3	534.0	554.5	576.6
	Power input	kW	37.2	38.3	39.9	43.8
	COP			4.06	4.09	4.07
Connected indoor unit	Combination ratio		50-130%			
	Maximum quantity		64			
Compressors	Type		DC inverter	DC inverter	DC inverter	DC inverter
	Quantity		3	4	4	3
Fan motors	Type		DC	DC	DC	DC
	Quantity		3	4	4	3
	Airflow rate	m ³ /h	44600	43500	43500	44600
	Static pressure	Pa	0-20 (standard) 20-120 (customized)	0-20 (standard) 20-120 (customized)	0-20 (standard) 20-120 (customized)	0-20 (standard) 20-120 (customized)
Refrigerant	Type		R410A	R410A	R410A	R410A
	Factory charge	kg	8+19	9.3+12	9.3+12	8+21
Pipe connections	Liquid pipe	mm	Ø19.1	Ø19.1	Ø19.1	Ø19.1
	Gas pipe	mm	Ø38.1	Ø38.1	Ø38.1	Ø38.1
Sound pressure level		dB(A)	65	65	65	67
Sound power level		dB(A)	94	96	96	95
Net dimensions (W×H×D)		mm	(940×1760×825)+ (1880×1760×825)	(1340×1760×825)×2	(1340×1760×825)×2	(940×1760×825)+ (1880×1760×825)
Packed dimensions (W×H×D)		mm	(1005×1945×890)+ (1945×1945×890)	(1405×1945×890)×2	(1405×1945×890)×2	(1005×1945×890)+ (1945×1945×890)
Net weight		kg	213+373	295+315	295+315	213+408
Gross weight		kg	230+403	315+335	315+335	230+438
Ambient temp. operation range	Cooling	°C(DB)	-15 to 55	-15 to 55	-15 to 55	-15 to 55
	Heating	°C(DB)	-30 to 30	-30 to 30	-30 to 30	-30 to 30

Notes:

- Indoor temperature 27°C DB, 19°C WB; outdoor temperature 35°C DB; equivalent refrigerant piping length 7.5m with zero level difference.
- Indoor temperature 20°C DB; outdoor temperature 7°C DB, 6°C WB; equivalent refrigerant piping length 7.5m with zero level difference.
- Diameters given are those for the pipe connecting the outdoor unit combination to the first indoor branch joint for systems with total equivalent liquid piping lengths of less than 90m. For systems with total equivalent liquid piping lengths of 90m or longer, please refer to the ERV8 Series Engineering Data Book for connection piping diameters.
- Sound pressure level is measured at a position 1m in front of the unit and 1.3m above the floor in a semi-anechoic chamber.

Specifications

HP			56	58	60	62
Model (Combination unit)			ERV8-533	ERV8-553	ERV8-572	ERV8-591
Combination type			18HP+38HP	20HP+38HP	22HP+38HP	24HP+38HP
Power supply			V/ph/Hz 380-415/3/50(60)	380-415/3/50(60)	380-415/3/50(60)	380-415/3/50(60)
Cooling	Capacity	kW	156.0	162.0	167.5	173.0
		kBtu/h	532.3	552.8	571.5	590.3
	Power input	kW	42.8	44.6	46.2	48.5
	COP			3.64	3.63	3.63
Heating	Capacity	kW	175.0	182.0	188.0	194.0
		kBtu/h	597.1	621.0	641.4	661.9
	Power input	kW	45.9	47.5	49.7	51.6
	COP			3.81	3.83	3.78
Connected indoor unit	Combination ratio		50-130%			
	Maximum quantity		64			
Compressors	Type		DC inverter	DC inverter	DC inverter	DC inverter
	Quantity		3	3	4	4
Fan motors	Type		DC	DC	DC	DC
	Quantity		3	3	4	4
	Airflow rate	m ³ /h	44600	45500	51000	51000
	Static pressure	Pa	0-20 (standard) 20-120 (customized)	0-20 (standard) 20-120 (customized)	0-20 (standard) 20-120 (customized)	0-20 (standard) 20-120 (customized)
Refrigerant	Type		R410A	R410A	R410A	R410A
	Factory charge	kg	8+21	8.4+21	9.3+21	9.3+21
Pipe connections	Liquid pipe	mm	Ø19.1	Ø19.1	Ø19.1	Ø19.1
	Gas pipe	mm	Ø41.3	Ø41.3	Ø41.3	Ø41.3
Sound pressure level		dB(A)	67	67	68	68
Sound power level		dB(A)	95	95	95	96
Net dimensions (W×H×D)		mm	(940×1760×825)+ (1880×1760×825)	(940×1760×825)+ (1880×1760×825)	(1340×1760×825)+ (1880×1760×825)	(1340×1760×825)+ (1880×1760×825)
Packed dimensions (W×H×D)		mm	(1005×1945×890)+ (1945×1945×890)	(1945×1945×890)+ (1005×1945×890)	(1405×1945×890)+ (1945×1945×890)	(1405×1945×890)+ (1945×1945×890)
Net weight		kg	213+408	215+408	295+408	295+408
Gross weight		kg	230+438	232+438	315+438	315+438
Ambient temp. operation range	Cooling	°C(DB)	-15 to 55	-15 to 55	-15 to 55	-15 to 55
	Heating	°C(DB)	-30 to 30	-30 to 30	-30 to 30	-30 to 30

HP			64	66	68	70
Model (Combination unit)			ERV8-612	ERV8-630	ERV8-652	ERV8-669
Combination type			26HP+38HP	28HP+38HP	30HP+38HP	32HP+38HP
Power supply			V/ph/Hz 380-415/3/50(60)	380-415/3/50(60)	380-415/3/50(60)	380-415/3/50(60)
Cooling	Capacity	kW	179.0	184.5	191.0	196.0
		kBtu/h	610.8	629.6	651.7	668.8
	Power input	kW	49.4	51.2	53.0	55.3
	COP			3.62	3.60	3.60
Heating	Capacity	kW	200.5	206.5	214.0	219.0
		kBtu/h	684.1	704.6	730.2	747.2
	Power input	kW	52.9	54.5	57.5	59.3
	COP			3.79	3.79	3.72
Connected indoor unit	Combination ratio		50-130%			
	Maximum quantity		64			
Compressors	Type		DC inverter	DC inverter	DC inverter	DC inverter
	Quantity		4	4	4	4
Fan motors	Type		DC	DC	DC	DC
	Quantity		4	4	4	4
	Airflow rate	m ³ /h	50500	50500	58000	57000
	Static pressure	Pa	0-20 (standard) 20-120 (customized)	0-20 (standard) 20-120 (customized)	0-20 (standard) 20-120 (customized)	0-20 (standard) 20-120 (customized)
Refrigerant	Type		R410A	R410A	R410A	R410A
	Factory charge	kg	12+21	12+21	19+21	21×2
Pipe connections	Liquid pipe	mm	Ø19.1	Ø19.1	Ø22.2	Ø22.2
	Gas pipe	mm	Ø41.3	Ø41.3	Ø44.5	Ø44.5
Sound pressure level		dB(A)	68	68	68	68
Sound power level		dB(A)	97	97	97	97
Net dimensions (W×H×D)		mm	(1340×1760×825)+ (1880×1760×825)	(1340×1760×825)+ (1880×1760×825)	(1880×1760×825)×2	(1880×1760×825)×2
Packed dimensions (W×H×D)		mm	(1405×1945×890)+ (1945×1945×890)	(1405×1945×890)+ (1945×1945×890)	(1945×1945×890)×2	(1945×1945×890)×2
Net weight		kg	315+408	315+408	373+408	373+408
Gross weight		kg	335+438	335+438	403+438	403+438
Ambient temp. operation range	Cooling	°C(DB)	-15 to 55	-15 to 55	-15 to 55	-15 to 55
	Heating	°C(DB)	-30 to 30	-30 to 30	-30 to 30	-30 to 30

Notes:

- Indoor temperature 27°C DB, 19°C WB; outdoor temperature 35°C DB; equivalent refrigerant piping length 7.5m with zero level difference.
- Indoor temperature 20°C DB; outdoor temperature 7°C DB, 6°C WB; equivalent refrigerant piping length 7.5m with zero level difference.
- Diameters given are those for the pipe connecting the outdoor unit combination to the first indoor branch joint for systems with total equivalent liquid piping lengths of less than 90m. For systems with total equivalent liquid piping lengths of 90m or longer, please refer to the ERV8 Series Engineering Data Book for connection piping diameters.
- Sound pressure level is measured at a position 1m in front of the unit and 1.3m above the floor in a semi-anechoic chamber.

Specifications

HP			72	74	76	78
Model (Combination unit)			ERV8-686	ERV8-707	ERV8-724	ERV8-743
Combination type			34HP+38HP	36HP+38HP	38HP+38HP	18HP+22HP+38HP
Power supply		V/ph/Hz	380-415/3/50(60)	380-415/3/50(60)	380-415/3/50(60)	380-415/3/50(60)
Cooling	Capacity	kW	201.2	207.0	212.0	217.5
		kBtu/h	686.5	706.3	723.4	742.1
	Power input	kW	57.0	59.3	61.2	58.4
	COP			3.53	3.49	3.46
Heating	Capacity	kW	225.0	231.0	238.0	244.0
		kBtu/h	767.7	788.2	812.0	832.5
	Power input	kW	61.4	63.8	66.2	62.5
	COP			3.66	3.62	3.60
Connected indoor unit	Combination ratio		50-130%			
	Maximum quantity		64			
Compressors	Type		DC inverter	DC inverter	DC inverter	DC inverter
	Quantity		4	4	4	5
Fan motors	Type		DC	DC	DC	DC
	Quantity		4	4	4	5
	Airflow rate	m ³ /h	57000	58000	58000	66600
	Static pressure	Pa	0-20 (standard) 20-120 (customized)	0-20 (standard) 20-120 (customized)	0-20 (standard) 20-120 (customized)	0-20 (standard) 20-120 (customized)
Refrigerant	Type		R410A	R410A	R410A	R410A
	Factory charge	kg	21×2	21×2	21×2	8+9.3+21
Pipe connections	Liquid pipe	mm	Ø22.2	Ø22.2	Ø22.2	Ø22.2
	Gas pipe	mm	Ø44.5	Ø44.5	Ø44.5	Ø44.5
Sound pressure level		dB(A)	68	69	69	68
Sound power level		dB(A)	97	97	97	96
Net dimensions (W×H×D)		mm	(1880×1760×825)×2	(1880×1760×825)×2	(1880×1760×825)×2	(940×1760×825)+ (1340×1760×825)+(1880×1760×825)
Packed dimensions (W×H×D)		mm	(1945×1945×890)×2	(1945×1945×890)×2	(1945×1945×890)×2	(1005×1945×890)+ (1405×1945×890)+(1945×1945×890)
Net weight		kg	405+408	405+408	408×2	213+295+408
Gross weight		kg	435+438	435+438	438×2	230+315+438
Ambient temp. operation range	Cooling	°C(DB)	-15 to 55	-15 to 55	-15 to 55	-15 to 55
	Heating	°C(DB)	-30 to 30	-30 to 30	-30 to 30	-30 to 30

HP			80	82	84	86
Model (Combination unit)			ERV8-762	ERV8-783	ERV8-801	ERV8-821
Combination type			18HP+24HP+38HP	18HP+26HP+38HP	18HP+28HP+38HP	20HP+28HP+38HP
Power supply		V/ph/Hz	380-415/3/50(60)	380-415/3/50(60)	380-415/3/50(60)	380-415/3/50(60)
Cooling	Capacity	kW	223.0	229.0	234.5	241.0
		kBtu/h	760.9	781.4	800.2	822.3
	Power input	kW	60.7	61.6	63.4	65.2
	COP			3.67	3.72	3.70
Heating	Capacity	kW	250.0	256.5	262.5	270.0
		kBtu/h	853.0	875.2	895.7	921.3
	Power input	kW	64.4	65.7	67.3	70.3
	COP			3.88	3.90	3.90
Connected indoor unit	Combination ratio		50-130%			
	Maximum quantity		64			
Compressors	Type		DC inverter	DC inverter	DC inverter	DC inverter
	Quantity		5	5	5	5
Fan motors	Type		DC	DC	DC	DC
	Quantity		5	5	5	5
	Airflow rate	m ³ /h	66600	66100	66100	73600
	Static pressure	Pa	0-20 (standard) 20-120 (customized)	0-20 (standard) 20-120 (customized)	0-20 (standard) 20-120 (customized)	0-20 (standard) 20-120 (customized)
Refrigerant	Type		R410A	R410A	R410A	R410A
	Factory charge	kg	8+9.3+21	8+12+21	8+12+21	8+19+21
Pipe connections	Liquid pipe	mm	Ø22.2	Ø22.2	Ø25.4	Ø25.4
	Gas pipe	mm	Ø44.5	Ø44.5	Ø50.8	Ø50.8
Sound pressure level		dB(A)	68	68	68	68
Sound power level		dB(A)	97	97	97	97
Net dimensions (W×H×D)		mm	(940×1760×825)+ (1340×1760×825)+ (1880×1760×825)	(940×1760×825)+ (1340×1760×825)+ (1880×1760×825)	(940×1760×825)+ (1340×1760×825)+ (1880×1760×825)	(940×1760×825)+ (1880×1760×825)×2
Packed dimensions (W×H×D)		mm	(1005×1945×890)+ (1405×1945×890)+ (1945×1945×890)	(1005×1945×890)+ (1405×1945×890)+ (1945×1945×890)	(1005×1945×890)+ (1405×1945×890)+ (1945×1945×890)	(1005×1945×890)+ (1945×1945×890)×2
Net weight		kg	213+295+408	213+315+408	213+315+408	213+373+408
Gross weight		kg	230+315+438	230+335+438	230+335+438	230+403+438
Ambient temp. operation range	Cooling	°C(DB)	-15 to 55	-15 to 55	-15 to 55	-15 to 55
	Heating	°C(DB)	-30 to 30	-30 to 30	-30 to 30	-30 to 30

Notes:

- Indoor temperature 27°C DB, 19°C WB; outdoor temperature 35°C DB; equivalent refrigerant piping length 7.5m with zero level difference.
- Indoor temperature 20°C DB; outdoor temperature 7°C DB, 6°C WB; equivalent refrigerant piping length 7.5m with zero level difference.
- Diameters given are those for the pipe connecting the outdoor unit combination to the first indoor branch joint for systems with total equivalent liquid piping lengths of less than 90m. For systems with total equivalent liquid piping lengths of 90m or longer, please refer to the ERV8 Series Engineering Data Book for connection piping diameters.
- Sound pressure level is measured at a position 1m in front of the unit and 1.3m above the floor in a semi-anechoic chamber.

Specifications

HP			88	90	92	94
Model (Combination unit)			ERV8-841	ERV8-859	ERV8-878	ERV8-895
Combination type			24HP+26HP+38HP	24HP+28HP+38HP	16HP+38HP+38HP	18HP+38HP+38HP
Power supply		V/ph/Hz	380-415/3/50(60)	380-415/3/50(60)	380-415/3/50(60)	380-415/3/50(60)
Cooling	Capacity	kW	246.0	251.5	257.0	262.0
		kBtu/h	839.4	858.2	876.9	894.0
	Power input	kW	67.3	69.1	71.9	73.4
	COP			3.66	3.64	3.57
Heating	Capacity	kW	275.5	281.5	288.0	294.0
		kBtu/h	940.0	960.5	982.6	1003.1
	Power input	kW	71.4	73.0	76.9	79.0
	COP			3.86	3.86	3.75
Connected indoor unit	Combination ratio		50-130%			
	Maximum quantity		64			
Compressors	Type		DC inverter	DC inverter	DC inverter	DC inverter
	Quantity		6	6	5	5
Fan motors	Type		DC	DC	DC	DC
	Quantity		6	6	5	5
	Airflow rate	m ³ /h	72500	72500	73600	73600
	Static pressure	Pa	0-20 (standard) 20-120 (customized)	0-20 (standard) 20-120 (customized)	0-20 (standard) 20-120 (customized)	0-20 (standard) 20-120 (customized)
Refrigerant	Type		R410A	R410A	R410A	R410A
	Factory charge	kg	9.3+12+21	9.3+12+21	8+21×2	8+21×2
Pipe connections	Liquid pipe	mm	Ø25.4	Ø25.4	Ø25.4	Ø25.4
	Gas pipe	mm	Ø50.8	Ø50.8	Ø50.8	Ø50.8
Sound pressure level		dB(A)	69	69	69	70
Sound power level		dB(A)	98	98	97	98
Net dimensions (W×H×D)		mm	(1340×1760×825)×2+ (1880×1760×825)	(1340×1760×825)×2+ (1880×1760×825)	(940×1760×825)+ (1880×1760×825)×2	(940×1760×825)+ (1880×1760×825)×2
Packed dimensions (W×H×D)		mm	(1405×1945×890)×2+ (1945×1945×890)	(1405×1945×890)×2+ (1945×1945×890)	(1005×1945×890)+ (1945×1945×890)×2	(1005×1945×890)+ (1945×1945×890)×2
Net weight		kg	295+315+408	295+315+408	213+408×2	213+408×2
Gross weight		kg	315+335+438	315+335+438	230+438×2	230+438×2
Ambient temp. operation range	Cooling	°C(DB)	-15 to 55	-15 to 55	-15 to 55	-15 to 55
	Heating	°C(DB)	-30 to 30	-30 to 30	-30 to 30	-30 to 30

HP			96	98	100	102
Model (Combination unit)			ERV8-915	ERV8-934	ERV8-953	ERV8-974
Combination type			20HP+38HP+38HP	22HP+38HP+38HP	24HP+38HP+38HP	26HP+38HP+38HP
Power supply		V/ph/Hz	380-415/3/50(60)	380-415/3/50(60)	380-415/3/50(60)	380-415/3/50(60)
Cooling	Capacity	kW	268.0	273.5	279.0	285.0
		kBtu/h	914.5	933.2	952.0	972.5
	Power input	kW	75.2	76.8	79.1	80.0
	COP			3.56	3.56	3.53
Heating	Capacity	kW	301.0	307.0	313.0	319.5
		kBtu/h	1027.0	1047.4	1067.9	1090.1
	Power input	kW	80.6	82.8	84.7	86.0
	COP			3.73	3.71	3.70
Connected indoor unit	Combination ratio		50-130%			
	Maximum quantity		64			
Compressors	Type		DC inverter	DC inverter	DC inverter	DC inverter
	Quantity		5	6	6	6
Fan motors	Type		DC	DC	DC	DC
	Quantity		5	6	6	6
	Airflow rate	m ³ /h	74500	80000	80000	79500
	Static pressure	Pa	0-20 (standard) 20-120 (customized)	0-20 (standard) 20-120 (customized)	0-20 (standard) 20-120 (customized)	0-20 (standard) 20-120 (customized)
Refrigerant	Type		R410A	R410A	R410A	R410A
	Factory charge	kg	8.4+21×2	9.3+21×2	9.3+21×2	
Pipe connections	Liquid pipe	mm	Ø25.4	Ø25.4	Ø25.4	Ø25.4
	Gas pipe	mm	Ø50.8	Ø50.8	Ø50.8	Ø50.8
Sound pressure level		dB(A)	70	70	70	70
Sound power level		dB(A)	98	98	98	99
Net dimensions (W×H×D)		mm	(940×1760×825)+ (1880×1760×825)×2	(1340×1760×825)+ (1880×1760×825)×2	(1340×1760×825)+ (1880×1760×825)×2	(1340×1760×825)+ (1880×1760×825)×2
Packed dimensions (W×H×D)		mm	(1005×1945×890)+ (1945×1945×890)×2	(1405×1945×890)+ (1945×1945×890)×2	(1405×1945×890)+ (1945×1945×890)×2	(1405×1945×890)+ (1945×1945×890)×2
Net weight		kg	215+408×2	295+408×2	295+408×2	315+408×2
Gross weight		kg	232+438×2	315+438×2	315+438×2	335+438×2
Ambient temp. operation range	Cooling	°C(DB)	-15 to 55	-15 to 55	-15 to 55	-15 to 55
	Heating	°C(DB)	-30 to 30	-30 to 30	-30 to 30	-30 to 30

Notes:

- Indoor temperature 27°C DB, 19°C WB; outdoor temperature 35°C DB; equivalent refrigerant piping length 7.5m with zero level difference.
- Indoor temperature 20°C DB; outdoor temperature 7°C DB, 6°C WB; equivalent refrigerant piping length 7.5m with zero level difference.
- Diameters given are those for the pipe connecting the outdoor unit combination to the first indoor branch joint for systems with total equivalent liquid piping lengths of less than 90m. For systems with total equivalent liquid piping lengths of 90m or longer, please refer to the ERV8 Series Engineering Data Book for connection piping diameters.
- Sound pressure level is measured at a position 1m in front of the unit and 1.3m above the floor in a semi-anechoic chamber.

Specifications

HP			104	106	108
Model (Combination unit)			ERV8-992	ERV8-1014	ERV8-1031
Combination type			28HP+38HP+38HP	30HP+38HP+38HP	34HP+36HP+38HP
Power supply			V/ph/Hz 380-415/3/50(60)	380-415/3/50(60)	380-415/3/50(60)
Cooling	Capacity	kW	290.5	297.0	302.0
		kBtu/h	991.3	1013.4	1030.5
	Power input	kW	81.8	83.6	85.7
	COP			3.55	3.55
Heating	Capacity	kW	325.5	333.0	337.0
		kBtu/h	1110.6	1136.2	1149.9
	Power input	kW	87.6	90.6	92.1
	COP			3.72	3.68
Connected indoor unit	Combination ratio		50-130%		
	Maximum quantity		64		
Compressors	Type		DC inverter	DC inverter	DC inverter
	Quantity		6	6	6
Fan motors	Type		DC	DC	DC
	Quantity		6	6	6
	Airflow rate	m ³ /h	79500	87000	86000
	Static pressure	Pa	0-20 (standard) 20-120 (customized)	0-20 (standard) 20-120 (customized)	0-20 (standard) 20-120 (customized)
Refrigerant	Type		R410A	R410A	R410A
	Factory charge	kg	12+21×2	19+21×2	21×3
Pipe connections	Liquid pipe	mm	Ø25.4	Ø25.4	Ø25.4
	Gas pipe	mm	Ø50.8	Ø50.8	Ø50.8
Sound pressure level		dB(A)	70	70	70
Sound power level		dB(A)	99	99	99
Net dimensions (W×H×D)		mm	(1340×1760×825)+ (1880×1760×825)×2	(1880×1760×825)×3	(1880×1760×825)×3
Packed dimensions (W×H×D)		mm	(1405×1945×890)+ (1945×1945×890)×2	(1945×1945×890)×3	(1945×1945×890)×3
Net weight		kg	315+408×2	373+408×2	405+408×2
Gross weight		kg	335+438×2	403+438×2	435+438×2
Ambient temp. operation range	Cooling	°C(DB)	-15 to 55	-15 to 55	-15 to 55
	Heating	°C(DB)	-30 to 30	-30 to 30	-30 to 30

HP			110	112	114
Model (Combination unit)			ERV8-1048	ERV8-1069	ERV8-1086
Combination type			34HP+38HP+38HP	36HP+38HP+38HP	38HP+38HP+38HP
Power supply			V/ph/Hz 380-415/3/50(60)	380-415/3/50(60)	380-415/3/50(60)
Cooling	Capacity	kW	307.2	313.0	318.0
		kBtu/h	1048.2	1068.0	1085.1
	Power input	kW	87.6	89.9	91.8
	COP			3.50	3.48
Heating	Capacity	kW	344.0	350.0	357.0
		kBtu/h	1173.7	1194.2	1218.0
	Power input	kW	94.5	96.9	99.3
	COP			3.64	3.61
Connected indoor unit	Combination ratio		50-130%		
	Maximum quantity		64		
Compressors	Type		DC inverter	DC inverter	DC inverter
	Quantity		6	6	6
Fan motors	Type		DC	DC	DC
	Quantity		6	6	6
	Airflow rate	m ³ /h	86000	87000	87000
	Static pressure	Pa	0-20 (standard) 20-120 (customized)	0-20 (standard) 20-120 (customized)	0-20 (standard) 20-120 (customized)
Refrigerant	Type		R410A	R410A	R410A
	Factory charge	kg	21×3	21×3	21×3
Pipe	Liquid pipe	mm	Ø28.6	Ø28.6	Ø28.6
	Gas pipe	mm	Ø54.0	Ø54.0	Ø54.0
Sound pressure level		dB(A)	70	70	70
Sound power level		dB(A)	99	99	99
Net dimensions (W×H×D)		mm	(1880×1760×825)×3	(1880×1760×825)×3	(1880×1760×825)×3
Packed dimensions (W×H×D)		mm	(1945×1945×890)×3	(1945×1945×890)×3	(1945×1945×890)×3
Net weight		kg	405+408×2	408×3	408×3
Gross weight		kg	435+438×2	438×3	438×3
Ambient temp. operation range	Cooling	°C(DB)	-15 to 55	-15 to 55	-15 to 55
	Heating	°C(DB)	-30 to 30	-30 to 30	-30 to 30

Notes:

- Indoor temperature 27°C DB, 19°C WB; outdoor temperature 35°C DB; equivalent refrigerant piping length 7.5m with zero level difference.
- Indoor temperature 20°C DB; outdoor temperature 7°C DB, 6°C WB; equivalent refrigerant piping length 7.5m with zero level difference.
- Diameters given are those for the pipe connecting the outdoor unit combination to the first indoor branch joint for systems with total equivalent liquid piping lengths of less than 90m. For systems with total equivalent liquid piping lengths of 90m or longer, please refer to the ERV8 Series Engineering Data Book for connection piping diameters.
- Sound pressure level is measured at a position 1m in front of the unit and 1.3m above the floor in a semi-anechoic chamber.

ERV8 Combination Table

HP	BTU/hr	Standard combination		Max. Qty. of indoor units
		Model	Combination type	
8	86,000	ERV8-086	single module	13
10	95,500	ERV8-096	single module	16
12	114,300	ERV8-114	single module	19
14	136,500	ERV8-137	single module	23
16	153,500	ERV8-154	single module	26
18	170,600	ERV8-171	single module	29
20	191,100	ERV8-191	single module	33
22	209,800	ERV8-210	single module	36
24	228,600	ERV8-229	single module	39
26	249,100	ERV8-250	single module	43
28	267,900	ERV8-268	single module	46
30	290,000	ERV8-290	single module	50
32	307,100	ERV8-307	single module	53
34	324,800	ERV8-324	single module	56
36	344,600	ERV8-345	single module	59
38	361,700	ERV8-362	single module	62
40	380,400	ERV8-381	ERV8-171 + ERV8-210	64
42	399,200	ERV8-400	ERV8-171 + ERV8-229	64
44	419,700	ERV8-421	ERV8-171 + ERV8-250	64
46	438,500	ERV8-439	ERV8-171 + ERV8-268	64
48	460,600	ERV8-461	ERV8-171 + ERV8-290	64
50	477,700	ERV8-479	ERV8-229 + ERV8-250	64
52	496,500	ERV8-497	ERV8-229 + ERV8-268	64
54	515,200	ERV8-516	ERV8-154 + ERV8-362	64
56	532,300	ERV8-533	ERV8-171 + ERV8-362	64
58	552,800	ERV8-553	ERV8-191 + ERV8-362	64
60	571,500	ERV8-572	ERV8-210 + ERV8-362	64
62	590,300	ERV8-591	ERV8-229 + ERV8-362	64
64	610,800	ERV8-612	ERV8-250 + ERV8-362	64
66	629,600	ERV8-630	ERV8-268 + ERV8-362	64
68	651,700	ERV8-652	ERV8-290 + ERV8-362	64
70	668,800	ERV8-669	ERV8-307 + ERV8-362	64
72	686,500	ERV8-686	ERV8-324 + ERV8-362	64
74	706,300	ERV8-707	ERV8-345 + ERV8-362	64
76	723,400	ERV8-724	ERV8-362 + ERV8-362	64
78	742,100	ERV8-743	ERV8-171 + ERV8-210 + ERV8-362	64
80	760,900	ERV8-762	ERV8-171 + ERV8-229 + ERV8-362	64
82	781,400	ERV8-783	ERV8-171 + ERV8-250 + ERV8-362	64
84	800,200	ERV8-801	ERV8-171 + ERV8-268 + ERV8-362	64
86	822,300	ERV8-821	ERV8-191 + ERV8-268 + ERV8-362	64
88	839,400	ERV8-841	ERV8-229 + ERV8-250 + ERV8-362	64
90	858,200	ERV8-859	ERV8-229 + ERV8-268 + ERV8-362	64
92	876,900	ERV8-878	ERV8-154 + ERV8-362 + ERV8-362	64
94	894,000	ERV8-895	ERV8-171 + ERV8-362 + ERV8-362	64
96	914,500	ERV8-915	ERV8-191 + ERV8-362 + ERV8-362	64
98	933,200	ERV8-934	ERV8-210 + ERV8-362 + ERV8-362	64
100	952,000	ERV8-953	ERV8-229 + ERV8-362 + ERV8-362	64
102	972,500	ERV8-974	ERV8-250 + ERV8-362 + ERV8-362	64
104	991,300	ERV8-992	ERV8-268 + ERV8-362 + ERV8-362	64
106	1,013,400	ERV8-1014	ERV8-290 + ERV8-362 + ERV8-362	64
108	1,030,500	ERV8-1031	ERV8-307 + ERV8-362 + ERV8-362	64
110	1,048,200	ERV8-1048	ERV8-324 + ERV8-362 + ERV8-362	64
112	1,068,000	ERV8-1069	ERV8-345 + ERV8-362 + ERV8-362	64
114	1,085,100	ERV8-1086	ERV8-362 + ERV8-362 + ERV8-362	64



WORLD STANDARD AIR CONDITIONERS



SIMILAR CO., LTD. (HEAD OFFICE)
235 Lasalle Road, Bangna-tai Sub-district,
Bangna District, Bangkok 10260 Thailand.

✉: marketing@eminent.co.th

🌐: www.eminent.co.th

📘: Eminent Air

☎: +66 2 083 5555

📄: +66 2 033 6235



Call Center ☎: +66 2 033 6229

📞: @eminentairservice

Distributed by